

XMC050

XM Satellite Radio

Bluetooth remote control

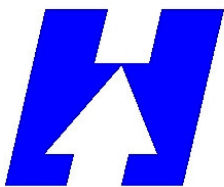

User Guide

Welcome

Thank you for purchasing a Heads Up Technologies XMC050 Satellite Radio Bluetooth System. Your XMC050 gives you access to over 150 XM Satellite Radio channels of music, news, sports, traffic

! **WARNING:** When using this product it is always important to maintain safe aircraft operation. Changes or modifications to this device not expressly approved by the manufacturer could void the user's authority to operate the equipment.

& weather, talk, comedy and more coast to coast.



About XMC050

XMC050 is the latest in the acclaimed line of electronics from Heads Up Technologies and XM Satellite Radio which represents the best in aviation satellite radio technology. XMC050 uses two new technologies – OLED and Bluetooth. OLED – Organic Light Emitting Diode uses less power than similar devices while providing superior illumination and graphics clarity. Bluetooth wireless communication provides the latest in industry RF transmission. Unlike traditional infrared systems requiring line of sight transmission, Bluetooth operates through low-density walls and other obstructions.



FCC ID # TGVXMSC43. This device complies with Part 15 of the FCC rules subject to the following two conditions:

- 1) This device may not cause harmful interference.
- 2) This device must accept all interference received, including interference that may cause undesired operation.

About Heads Up Technologies

Heads Up Technologies designs, manufactures and markets electronic solutions for the aviation industry. At Heads Up, we've provided integrated digital voice and data systems to more than 2,500 customers across the world. Our users include OEM/airframe manufacturers, major/regional airlines and corporate and private



fixed-wing and helicopter operators. We also provide Design and Manufacturing Services to clients in other industries, including entertainment and government. A turnkey solutions provider, Heads Up is based in Dallas, Texas - but serves the world.

About XM

One big idea can change everything. And XM Satellite Radio is one big idea: Radio to the Power of X®. America's most popular satellite radio service offers over 150 digital channels of sheer variety: music, sports, talk, comedy, drama, news, traffic and weather, kids programming, and more. All XM music channels are 100 percent



commercial-free, and XM's instant traffic and weather channels provide the most comprehensive, in-depth information on traffic incidents, delays, and road conditions available on radio. These services are available for a low monthly subscription, and additional devices may qualify for a reduced subscription fee through the XM Family Plan.

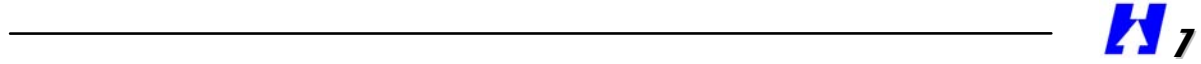

Table of Contents

GETTING STARTED: ACTIVATING XMC050 10

XMC050 CASE..... 13

TAKING CARE OF YOUR XMC050 14

BATTERY INSTALLATION 15

XMC050 CONTROLS..... 16

XMC050 DISPLAY SCREEN 17

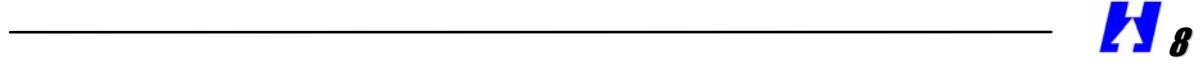

XMC050 FUNCTION BUTTONS.....	19
BASIC OPERATIONS	24
TROUBLESHOOTING	34
XM SATELLITE RADIO LIMITED CONSUMER WARRANTY	35



Getting Started: Activating the receiver

To quickly begin enjoying XM Satellite Radio, follow these simple steps:

- Locate the identification label on the receiver. On the label is the two-digit receiver identification number. Write the number Here (Do NOT skip this step!!!):



- Activate your receiver with XM Satellite Radio by using the installation instructions that came with your receiver.
- Press the power button to turn your XMC050 on and verify that it is playing channel 1, the XM Preview Channel.

Now you can contact XM Satellite Radio to activate. Make sure you have a major credit card and your XM Satellite Radio ID number handy and contact XM at <http://activate.xmradio.com>. You may also activate your service by calling 1-800-985-9200.



Note: You will need to keep your receiver on for at least one hour after activation to receive the full channel lineup. It is not necessary to keep your remote on during this time.



XMC050 Case

XMC050 is made from a high strength, painted polymer. It includes two attachment points.

- One for a lanyard that is supplied for those operators who desire to secure the XMC050 to provisions in the seatback (fabric loop inside the seat pocket) or other suitable location.
- A clip that can be used to attach the XMC050 to fabric, vinyl or

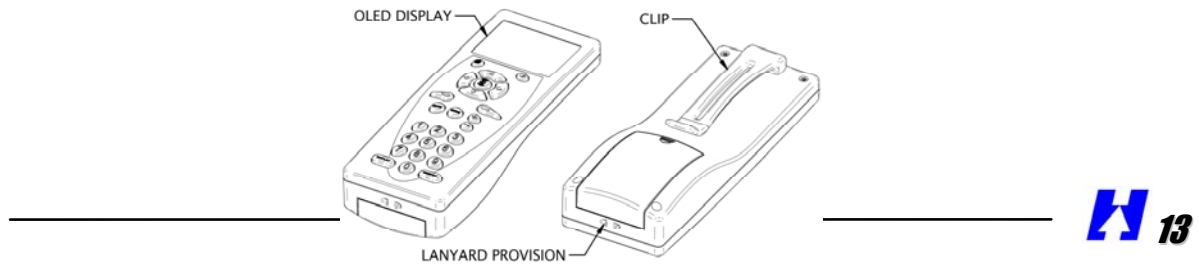

leather pouches, pockets and belts.

Taking Care of Your XMC050

Important:

Use only a soft, dry cloth to clean the outside of your XMC050. Do not use any solvents, chemicals, or cleaning solutions containing alcohol, ammonia, or abrasives. Do not allow liquids to spill on the unit. Do not use sprays near your XMC050. It is best to keep the XMC050 out of direct sunlight or other sources of extreme heat.

Battery Installation

The XMC050 requires three AAA batteries to operate. Please note proper battery orientation. Battery life is affected by usage.

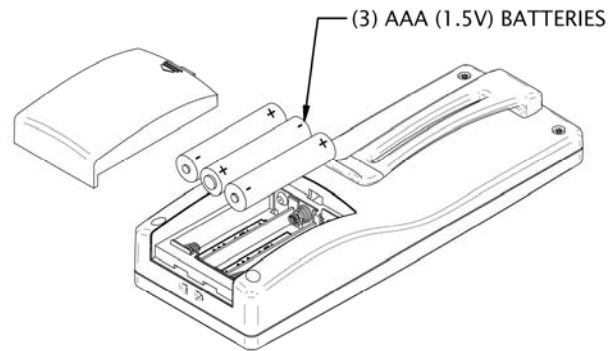

XMC050 Controls

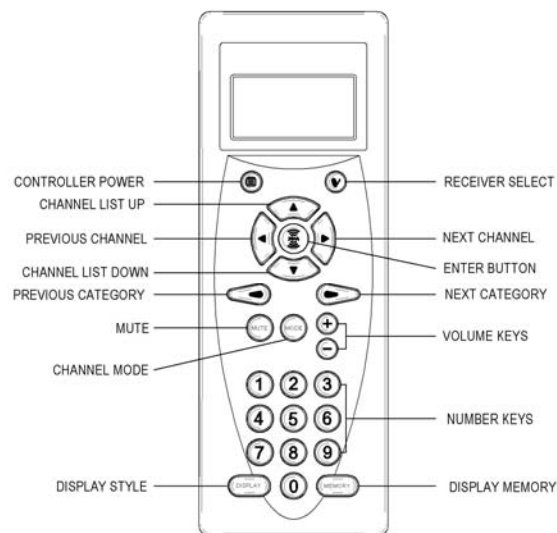





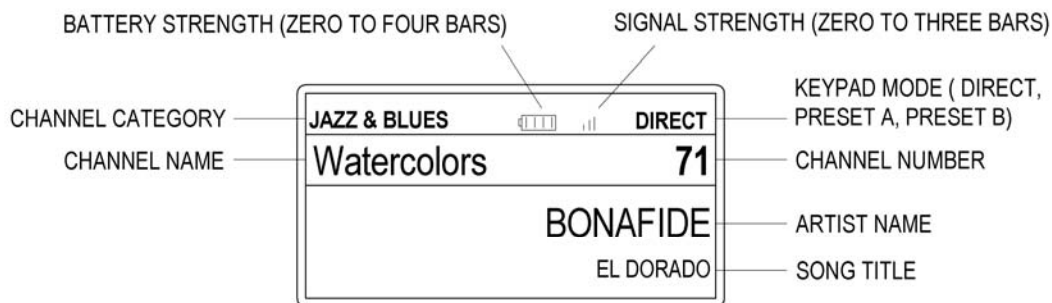

XMC050 Display Screen



While tuned to an XM channel, the XMC050 default display contains information about that channel and the XMC050 settings.





XMC050 Function Buttons

	<p>Controller power. Turns the XMC050 on or off.</p>
	<p>Receiver Select. Searches for and sets the receiver ID. FOR MAINTAINENCE USE ONLY! Password is required for use. Password is 4881. If you access and change your receiver ID you will not be able to control the receiver with your remote. To resolve this, you will need to enter the correct</p>

	<p>receiver ID that you wrote down on page 8.</p>
	<p>Channel List Up and Down. Used to move up or down through channel lists.</p>
	<p>Previous and Next channel.</p>
	<p>Channel List Enter. Used to select highlighted channel.</p>
	<p>Previous and Next Category. Provides category search and displays channels grouped by category. Continued presses step through</p>

	available categories. Use the 'Channel List Up and Down' buttons to scroll through channels within a category. Press 'Channel List Enter' button to select channel.
	Audio Mute. This button mutes and unmutes the audio output.
	Channel Mode Key - Provides selection between "Direct" (Direct Channel Entry), Preset "A" and Preset "B" options.

	Volume Up and Down.
	Number keys (0-9). Number keys are used to select a channel directly (when in Direct Entry mode), and to select or set presets when in a Preset mode.
	Display Format Select. The display button toggles between two display options: <ul style="list-style-type: none"> - Channel name, channel number, artist name, song title. - Channel name, and a big channel number.



Memory. Press Memory to save artist name and song title information. Press and hold the memory key to recall information.

Basic Operations

Turning the XMC050 On and Off

Press the  button on the XMC050. When first turned on, the receiver will power up in mute mode, and remain muted until a connection is established with the remote. After the connection is established the volume level and channel are changed to previous settings.

Direct Channel Selection

The system should be in Direct Entry mode. “Direct” will appear in the upper right corner of the display. If A, B appears, press ‘Channel Mode Key’ until the display says “Direct.” Then, enter your desired channel number using the number keys, *e.g., 5 then 0 for Channel 50.*

Channel presets

Your XMC050 can store up to 20 preset channels. They are organized into two different groups (Preset A and Preset B), each with 10 channels corresponding to the 10 number keys. For the tenth preset in each group, press the “0” key.



Setting channel presets



1. Tune in the channel you want to register as a preset, making sure it is playing.
2. Select either Preset A, or Preset B by pressing  until an A or B appears in the upper right corner of the display.
3. Press and hold the number key corresponding to the preset you would like to set. The upper right corner of the display will change to indicate the preset channel “A-1”.
4. When you first get your XMC050, all presets go to Channel 1.



Selecting channel presets

Press the  button until an A or B appears in the upper right corner of the display. Press the number key corresponding to the desired preset.

Select a channel by category

Press either of the category keys   to enter category search.

1. Continue pressing one of the category keys until a category you are interested in appears.



2. Press the  to move between the channels within the category.

3. Press  to tune to the selected channel.

4. If you do not select a channel, category search will time out after several seconds.

5. Pressing the  key changes from channel names to artist names to song names back to channel names.

6. Holding the up/down-arrow key auto-repeats them.



Select a channel by channel name

Press either of the  to enter channel search.

1. Press the up-arrow or down-arrow to move between the channels.
2. Press  to tune to the selected channel.
4. If you do not select a channel, channel search will time out after several seconds.

5. Pressing the  key changes from channel names to artist names to song names back to channel names.
6. Holding the up/down-arrow key auto-repeats them.

Changing the Display

Pressing  lets you change what is shown on your three-line XMC050 display during normal listening from among options:

- Display mode 1 (factory default): Shows the channel name and channel number on the first line, the artist name on the second line and song title on the third line.

- Display mode 2: Shows the channel name on the first line, and a big channel number on the second line.

Save and Recall Artist Name and Song Title Information

You can save the artist name and song title on the current channel for future reference.

1. Press  and release to save the current screen information. Up to 10 different artist and song titles can be saved, after which any new information that is saved will replace the oldest information in memory.



2. To recall saved information, press  and hold for 3 seconds. Next, use the Channel List buttons to display each saved artist name/song title.

Audio Level



Use  to adjust the XMC050 audio-output level if it is too high, causing distortion, or if too low. Most users will not need to change this level from the factory setting. You should set the volume using the audio system connected to your XMC050. Holding the +/- keys auto-repeats them.



Power Conservation

The XMC050 uses two methods to extend battery life:

- 1.) After 30 seconds of inactivity (no key presses) the display will shut off. By pressing any key the screen will turn on.

- 2.) After 3 minutes of inactivity the remote will shut off. The remote can be turned back on by pressing the  button

Troubleshooting

Your XMC050 has been designed and built to provide you with trouble-free performance. If it does not appear to be functioning correctly, please follow these troubleshooting steps:

1. Make sure the batteries are charged and properly installed.
2. Make sure all connectors are properly attached.

If this happens:	You should:
You do not receive all subscribed XM Channels. Cause: Your receiver is not activated.	Contact XM Satellite Radio
The audio sounds distorted	Reduce audio-output level
The audio level is too low	Increase audio-output level
You cannot tune to a channel	Verify that you are authorized to receive that channel as part

	of your subscription with XM and that you have not asked XM to block that channel.
No song title or artist name	Nothing is wrong with your receiver. This is normal on many talk and news channels. Also, this information may not yet be in the channel lineup for some selections.
The audio on the XM instant traffic and weather channels	Nothing is wrong with your receiver. These channels use

does not sound the same as the other XM channels.

a different audio technology than the main XM channels in order to provide many different dedicated city channels.

Contacting Product Technical Support and Customer Service

For additional information in solving problems, contact:

Heads Up Technologies at 1.972.980.4890 Monday—Friday,
8:00am—5:00pm Central Standard Time.



XM Satellite Radio Limited Consumer Warranty

Heads Up Technologies

Limited Warranty – Satellite Radio Products

Heads Up Technologies, Inc., hereby warrants that it will repair or replace, at its option, any part of the Heads Up product with which this warranty is enclosed which proves defective by reason of improper workmanship and/or material, without charge for parts or labor. The XM radio/weather receiver is covered for a period of 2 years and the XM remote is covered for a period of 1 year. This warranty period commences upon the in-service date, or six months from Heads Up invoice to buyer, whichever is later, and only if such original purchase by the buyer was made in the United States.



Products supplied by and not manufactured by Heads Up shall be covered by the original manufacturer's warranty.

To obtain service under this warranty you must return your Heads Up product or component as instructed in the maintenance manual, packaged in the original shipping container or an equivalent, to the nearest authorized service center or the dealer from whom the product was purchased. Any postage, insurance, shipping, and installation costs incurred in presenting your Heads Up product for service are your responsibility. The original bill of sale or other satisfactory proof of the date of the original purchase of your HEADS UP product must be made available to obtain service under this warranty.

This warranty applies only if your Heads Up product fails to function under normal use and within the manufacturer's specifications. This warranty does not apply if the



Heads Up label or logo, or the rating or serial number, has been removed from your Heads Up product, or if, in the sole opinion of Heads Up, your Heads Up product has been damaged by accident, misuse, neglect, failure to perform the prescribed maintenance procedures, or improper packing, shipping, modification or servicing, by other than a Heads Up authorized technician.

This Heads Up product contains static-sensitive electronic circuitry. Do not open case except at Heads Up approved static controlled workstations! This warranty will become void if you attempt to modify or adjust any internal components or the contents of any EPROM, or if you add or insert another ROM or part of any other device not provided by Heads Up. Failure to adhere to instructions specified in the operations and maintenance manuals voids this warranty.



The duration of any implied warranty of merchantability, fitness for a particular purpose, or otherwise, on your Heads Up product shall be limited to the duration of the expressed warranty set forth above. In no event shall Heads Up Technologies, Inc. or its affiliates be liable for any loss, inconvenience or damage whether direct, incidental, consequential or otherwise, or whether caused by negligence or other fault resulting from breach of any express or implied warranty of merchantability, fitness for a particular purpose, or otherwise, with respect to your Heads Up product, except as specified herein. Some states do not allow limitations on how long an implied warranty lasts and some states do not allow the exclusion or limitation of incidental or consequential damages, so the above limitations and exclusions may not apply to you.





H E A D S U P T E C H N O L O G I E S

Rev. 7/19/2005